

# R15IT3S-MRM2

## 15" Intel® Core™ i7-1165G7 Marine Panel PC

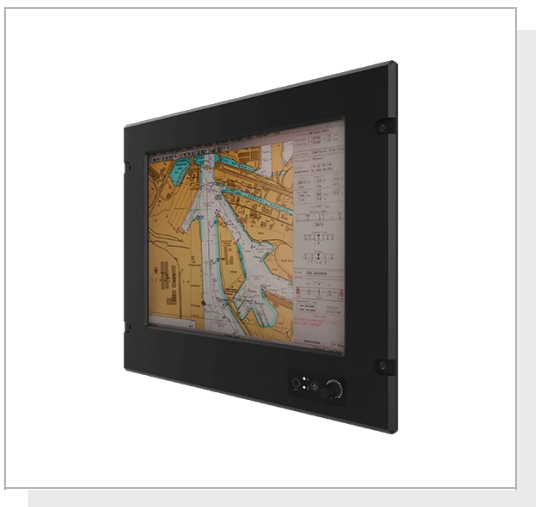

### KEY FEATURES

- Intel® Core™ i7-1165G7 processor marine panel PC
- Dimming knob control backlight brightness from nearly 0% to 100%
- 9~36V DC power input acceptable
- Panel (flush) mount IP66 aluminum housing with powder coating design



### SPECIFICATIONS

Display			
<b>Touch / Glass</b>	Resistive Touch Screen AR Glass (Optional)	<b>Resolution</b>	1024x768
<b>Size</b>	15 inches	<b>Contrast Ratio</b>	2000:1
<b>Panel Brightness</b>	300 nits	<b>View Angles</b>	88,88,88,88
<b>Active Area</b>	304.1x228.1 mm		
System Specification			
<b>Processor</b>	Intel Core i7-1165G7 2.8GHz (up to 4.7GHz)	<b>Memory</b>	1 x SO-DIMM, DDR4 2400 MHz, 4GB 8GB (Optional) 16GB (Optional) 32GB (Optional)
<b>Storage</b>	1 x M.2 2242 B-key SSD 128GB M.2 2242 B-key SSD up to 512GB (Optional) M.2 2280 M-Key NVME SSD, up to 4TB (Optional)	<b>Ethernet controller</b>	2 x Intel® Ethernet Controller
<b>Operating System</b>	Windows 10 IoT Enterprise (64 bit) (Optional) Windows 11 IoT Enterprise SAC (64 bit) (Optional) Linux Ubuntu 22.04 (Optional)		
Environment			
<b>Operating Humidity</b>	5% to 95%	<b>Operating Temperature</b>	-15~55°C
<b>Shock</b>	15G, 11ms duration	<b>Vibration</b>	0.7g@DNVGL CG-0339 (Class A)
<b>IP rating</b>	IP66 (Front Side)		
Certification			
<b>Certification</b>	CE, FCC		
Mechanical			
<b>Dimension</b>	412 x 345 x 71.7 mm	<b>Mounting</b>	VESA Mount/ Panel Mount
<b>Enclosure</b>	Metal Housing with Aluminum Bezel	<b>Cooling System</b>	Fanless Design
<b>Cut out</b>	338 x 288mm		
IO Ports			
<b>USB Port</b>	2 x USB 3.0	<b>Serial Port</b>	1 x RS232, 4 x RS232 or 4 x Isolation RS422/485 (Optional)
<b>Video</b>	1 x VGA	<b>LAN</b>	2 x RJ45-10/100/1000 Mbps

1 x HDMI (Optional)

## Accessory

**Accessory** Driver CD & User Manual  
4 x M6 Black Screw Bolt with M6 Nut  
1 x AC Adapter 12V/ 84W  
1 x Power Cord

## Power

**Power Rating** 24V DC-in with Isolation (Approval by Certificate)      **Consumption** 55W (Typical)  
9~36V DC Input Acceptable

## Control

**Button** 1 x Power Button  
1 x Reset Button  
1 x The Dimming Knob

## DIMENSIONS UNIT:MM

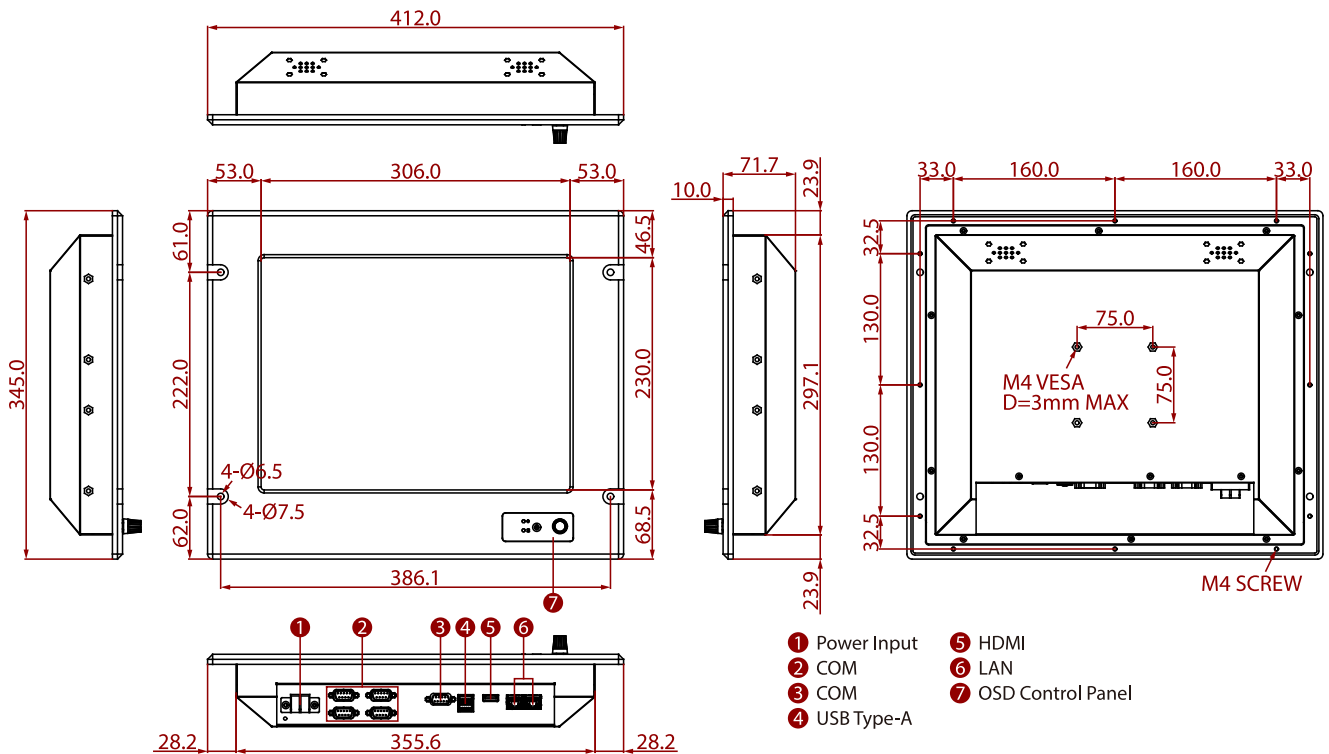

## NOTE

- 1.This is a simplified drawing and some components are not marked in detail.
- 2.Please contact our sales representative if you need further product information.
- 3.All specifications are subject to change without prior notice.
- 4.The product shown in this datasheet is a standard model.For diagrams that contain customized or optional I/ O, please contact the Winmate Sales Team for more information.